

TA1B6

VORTICE 130

TA1B9

VORTICE 160



TARGET POINT NEW S.R.L.
36056 - Tezze sul Brenta (VI)
Tel +39 0424 219797 - Fax +39 0424 898443
www.targetpoint.it - info@targetpoint.it

AVVERTENZA: la manomissione, lo smontaggio non autorizzato, la mancata osservanza delle istruzioni per l'uso, il tentativo di riparazione da parte di personale non qualificato, rendono nulla la garanzia.

WARNING: tampering, unauthorized disassembling, failure to comply with these instructions, attempted reparations by unqualified personnel will invalidate the product warranty.

ADVERTENCIA: la manipulación, el desmontaje no autorizado, el incumplimiento de las instrucciones de uso, los intentos de reparación por parte de personal no calificado, invalidan la garantía sobre el producto.

AVERTISSEMENT: la manumission, le démontage non autorisé, le non-respect des instructions d'utilisation, les tentatives de réparation par personnel non qualifié, annulent la garantie sur le produit.

TA1B6

VORTICE 130







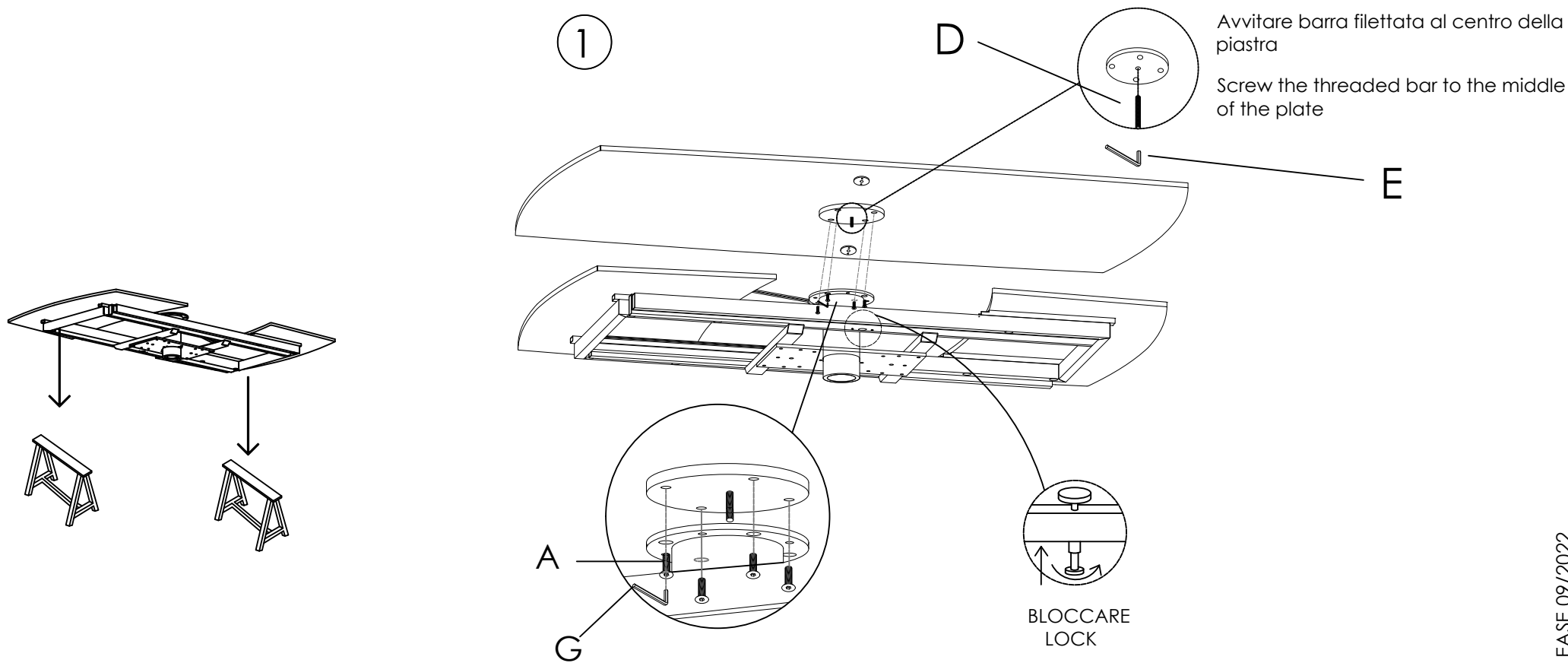

TA1B9

VORTICE 160



TARGET POINT NEW S.R.L.
 36056 - Tezze sul Brenta (VI)
 Tel +39 0424 219797 - Fax +39 0424 898443
 www.targetpoint.it - info@targetpoint.it

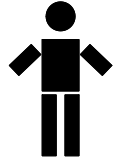

A	B	C	D	E	F	G		
 M8 x 12		 M8 x 20		 CH 4	 CH 6	 CH 5		
× 4	× 6	× 6	× 1	× 1	× 1	× 1	× 2	× 2

TA1B6

VORTICE 130

TA1B9

VORTICE 160



TARGET POINT NEW S.R.L.
36056 - Tezze sul Brenta (VI)
Tel +39 0424 219797 - Fax +39 0424 898443
www.targetpoint.it - info@targetpoint.it

2

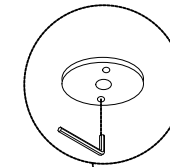
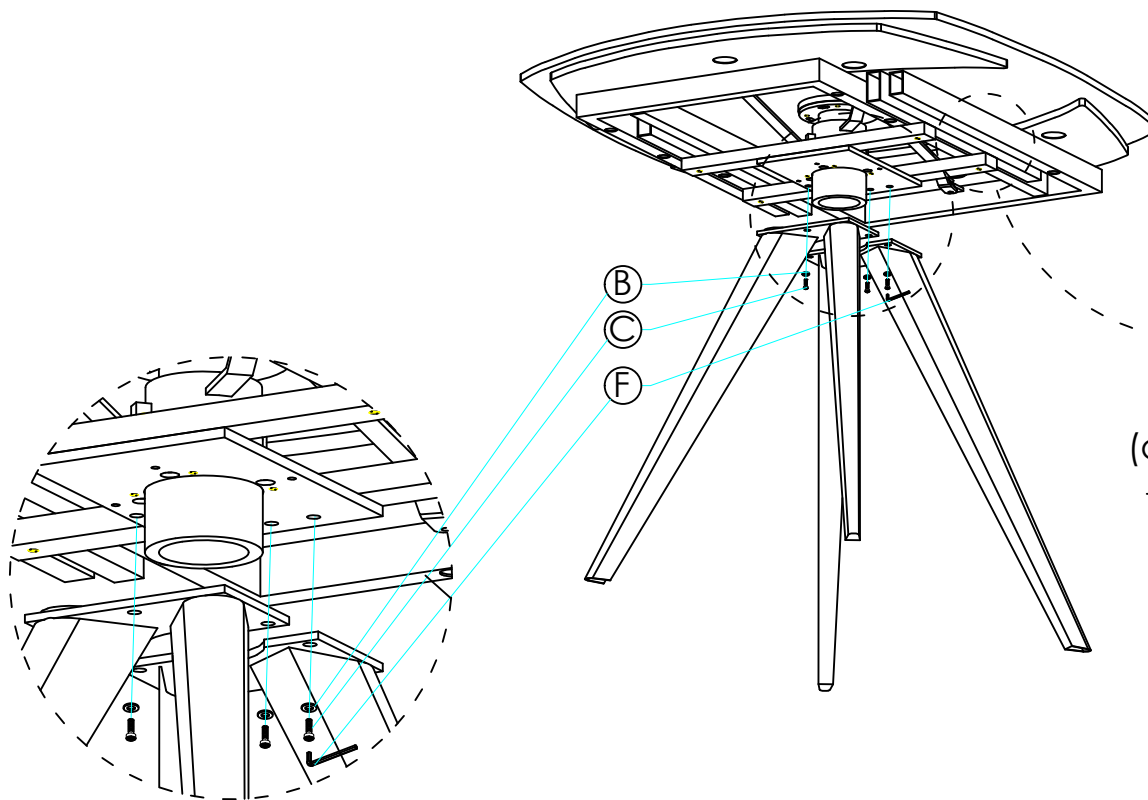

Se necessario, regolare posizione piastrina per inserimento del perno

If necessary, adjust the plate position in order to match the pin position

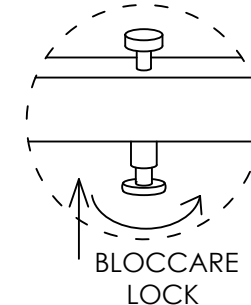
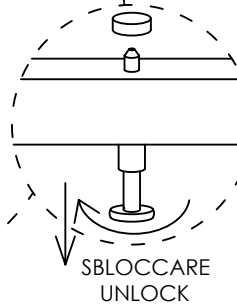

sbloccare solo nel momento di rotazione
(apertura/chiusura del tavolo); poi bloccare nuovamente

unlock only during the rotation (opening / closing of the
table); then lock again

3

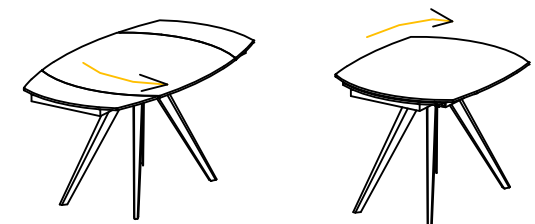

TA1B6

VORTICE 130

EXTENSION ADJUSTMENT (if necessary) REGOLAZIONE ALLUNGHE (se necessario)



TARGET POINT NEW S.R.L.
36056 - Tezze sul Brenta (VI)
Tel +39 0424 219797 - Fax +39 0424 898443
www.targetpoint.it - info@targetpoint.it

4

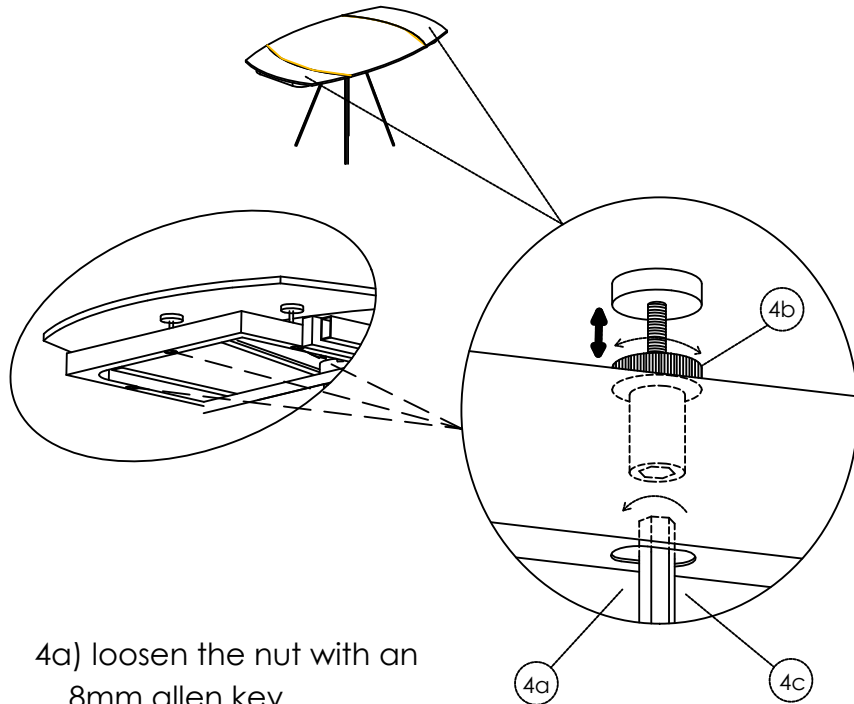

4a) loosen the nut with an 8mm allen key
allentare il dado con una chiave a brugola da 8mm

4b) adjust the extension
regolare l'allunga

4c) tighten the nut
serrare il dado

5

ADJUSTMENTS IF THE TABLE DOESN'T COMPLETELY OPEN

REGOLAZIONI IN CASO DI NON COMPLETA APERTURA DEL PIANO

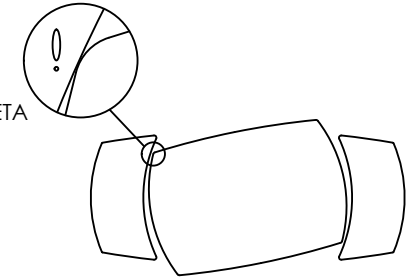

5a) loosen the nut with an 8mm allen key

allentare il dado con una chiave a brugola da 8mm

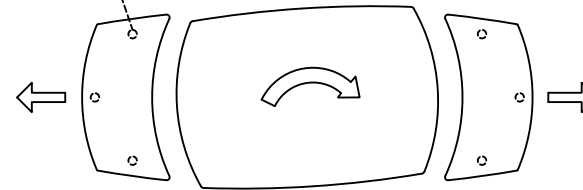
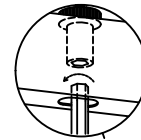

5b) pull the extensions outwards and complete the central piece movement

tirare le allunghe verso l'esterno e completare il movimento del piano centrale

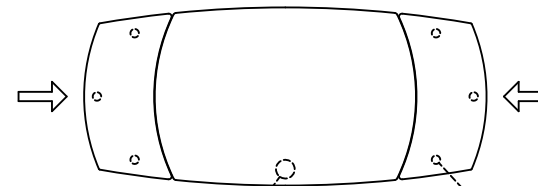

5c) lock the central piece and push the extensions inwards without leaving gaps

bloccare il piano centrale e spingere le allunghe verso l'interno senza lasciare spazi

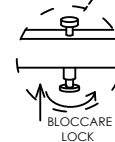

5d) fasten the nut with an 8mm allen key

stringere il dado con una chiave a brugola da 8mm

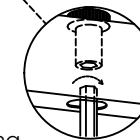

TA1B9

VORTICE 160

EXTENSION ADJUSTMENT (if necessary) REGOLAZIONE ALLUNGHE (se necessario)



TARGET POINT NEW S.R.L.
36056 - Tezze sul Brenta (VI)
Tel +39 0424 219797 - Fax +39 0424 898443
www.targetpoint.it - info@targetpoint.it

4

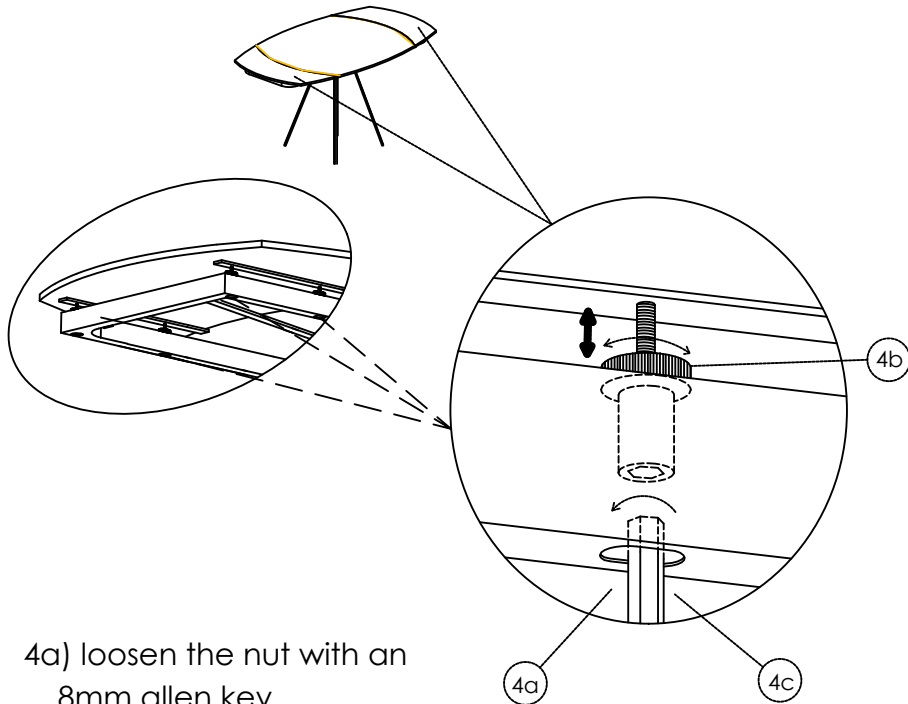

4a) loosen the nut with an 8mm allen key
allentare il dado con una chiave a brugola da 8mm

4b) adjust the extension
regolare l'allunga

4c) tighten the nut
serrare il dado

5

ADJUSTMENTS IF THE TABLE DOESN'T COMPLETELY OPEN

REGOLAZIONI IN CASO DI NON COMPLETA APERTURA DEL PIANO

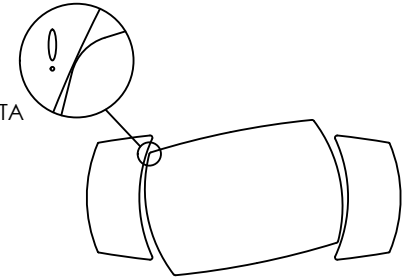

5a) loosen the nut with an 8mm allen key

allentare il dado con una chiave a brugola da 8mm

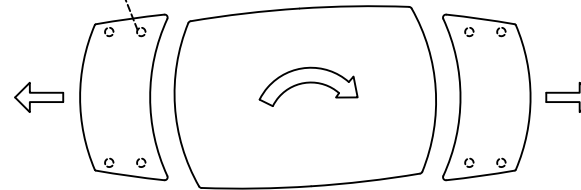
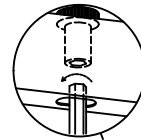

5b) pull the extensions outwards and complete the central piece movement

tirare le allunghe verso l'esterno e completare il movimento del piano centrale

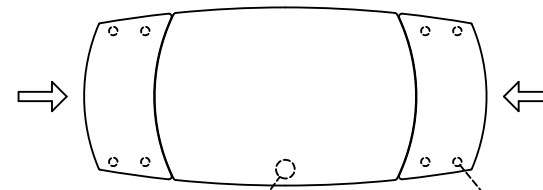

5c) lock the central piece and push the extensions inwards without leaving gaps

bloccare il piano centrale e spingere le allunghe verso l'interno senza lasciare spazi

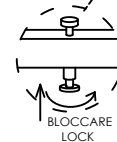

5d) fasten the nut with an 8mm allen key

stringere il dado con una chiave a brugola da 8mm

